

Decorative Curtain Poles





Hand Operated Curtain Pole System

Silent Gliss® 1003M Metropole 23mm

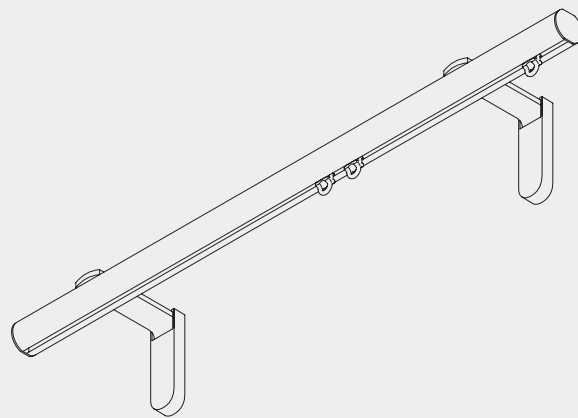

Product Information

- Hand operated decorative curtain poles for domestic and contract applications
- Ideal for bay windows
- For light to medium weight curtains
- Made to measure
- Profile length 6m (chrome effect 3.95m)
- 6 different finishes - black, silver, chrome effect, gunmetal, taupe and white
- Range of decorative finial designs in different styles and colours
- Wall fix or ceiling fix
- Unlike other poles, 1003 can be bent to a small radius for bay windows etc. whilst retaining efficient operation



1003M

Profile, Bending and Specification Information

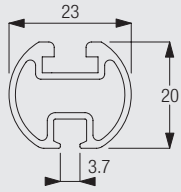

1003



Standard radius 150mm

Specification Guide - download from www.silentgliss.co.uk (password required).

Silent Gliss 1003 curtain track, hand drawn, aluminium, assembled complete with gliders 3533 at 16/m, 2 endcovers 0339 and 2 endstops 3070. Face fix with brackets 3134/6/ 0537/ 0334. Top fix with 6138P/ 0335. Available in black, white, silver, gunmetal, taupe and chrome effect.

How To Measure

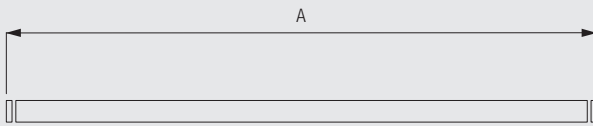

A: System Width - includes finials. See 'Design Options' for finial sizes.

Design Options

Endcaps

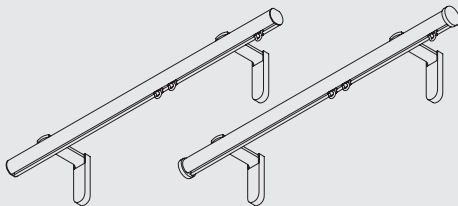

Without finials, poles are supplied as standard with flush fitting endcaps 0339 (left). Alternatively, stud endcaps 0706 (right) can be selected at no additional cost.



1003M

Finials

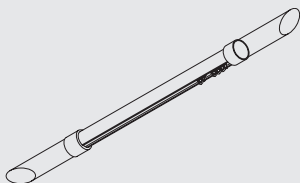

Finials are decorative elements that fit at the end of the pole.

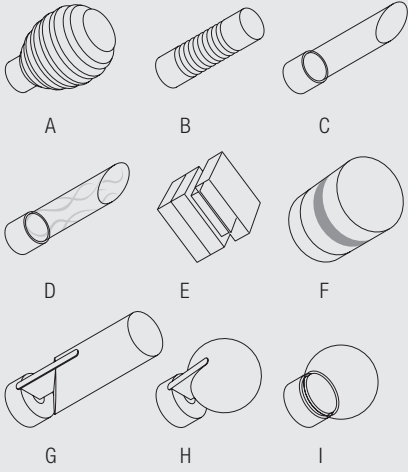

- A: 0985 Groove Ball 85mm
- B: 0628 Groove Cylinder 80mm
- C: 0993CL Shard (clear) 112mm
- D: 0993ET Shard (etched) 112mm
- E: 0884 Crystal Cube 33mm (green, black, brown)
- F: 0894 Crystal Cylinder 55mm (green, black, brown)
- G: 0308 Fused Barrel 90mm (walnut/oak/colour matched)
- H: 0321 Fused Ball 48mm (walnut/oak/colour matched)
- I: 0329 Glass Ball (clear/frosted) 45mm

Consult the Metropole brochure for full range details.

Fitting Information

Bracket positioning when using standard brackets 3134-3136



Fitting of track to brackets

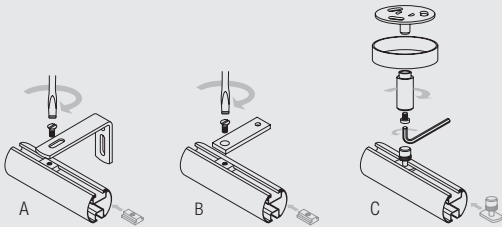

- A: Using brackets 3134/2 - 3136/2
- B: Using top fix plate 6138P
- C: Using top fix bracket 0335



1003M

Fitting of bent poles

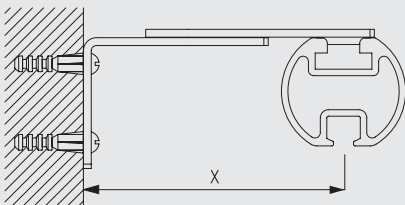

Note: all bent Metropole systems are supplied with adjustable brackets 0537 as standard.

Fitting Options

Wall fix with brackets 3134-36/2

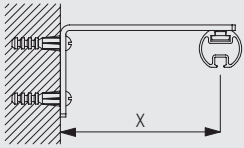

	X (mm)
3134/2	52
3135/2	72
3136/2	92

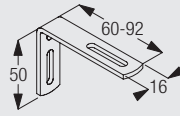

3134/2-3136/2
Extension brackets

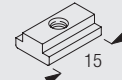

6141
Track insert (uses
screw 0798)

Ceiling fix with support 6138P

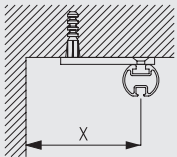

	X (mm)
6138P	80

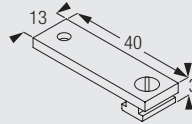

6138p
Ceiling support set
(3mm)

The final distances may be outside of the recommendation above depending on curtain make-up and any obstructions.

Wall fix with adjustable bracket 0537

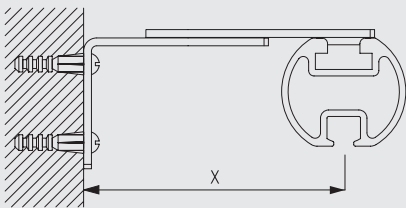

	X (mm)
0537	80-100

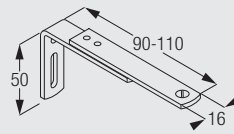

0537
Adjustable bracket

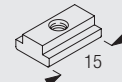

6141
Track insert (uses
screw 0798)



1003M

All bent Metropole poles are supplied with these adjustable brackets as standard.

Ceiling fix with top fix bracket 0335

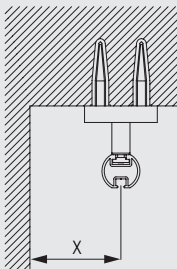

	X (mm)
0335	50

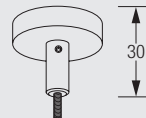

0335
Top fix bracket

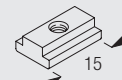

6141
Track insert (uses
screw 0798)

Standard Accessories

0339 Flush endcap (23mm)



0537 Adjustable bracket

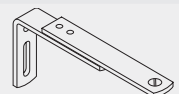

1003 Profile



3070 Twist eye endstop



3133	Bracket cover (60mm)		3534	Glider 3533 in strip form	
6141	Track insert (uses screw 0798)		6784	Machine screw (for 6141 insert)	
3134/2	Pole extension bracket (60mm - all colours)				

Optional Accessories

0308	Fused barrel (23mm)		0321	Fused ball (23mm)	
0329	Glass ball (23mm)		0335	Top fix bracket	
0628	Groove Cylinder (23mm)		0706	Stud Endcap (23mm)	
0732	Hexagonal nut		0733	M6 washer for midial	
0884	Crystal cube (23mm pole)		0894	Crystal cylinder (23mm)	
0985	Groove Ball (23mm)		0989	Blok Bracket	
3582	Hook		10430	Draw rod with hook, 50cm	
10431	Draw rod with hook, 75cm		10432	Draw rod with hook, 100cm	
10433	Draw rod with hook, 125cm		10434	Draw rod with hook, 150cm	
3134/2	Pole extension bracket (60mm - all colours)		3135/2	Pole extension bracket (80mm - all colours)	
3136/2	Pole extension bracket (100mm - all colours)		6138p	Ceiling support set (3mm)	
0993CL	Shard Clear (23mm)		0993ET	Shard Etched (23mm)	

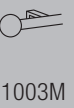

1003M

www.silentgliss.co.uk

www.silentglissglobal.com

Silent Gliss Ltd
Pyramid Business Park
Poorhole Lane
Broadstairs
Kent
CT10 2PT
Great Britain

Tel: +44 (0) 1843 863571
Fax: +44 (0) 1843 864503
info@silentgliss.co.uk

Silent Gliss Global Ltd
Pyramid Business Park
Poorhole Lane
Broadstairs
Kent
CT10 2PT
Great Britain

Tel: +44 (0) 1843 874250
Fax: +44 (0) 1843 874457
info@silentglissglobal.com