

Hand Operated Curtain Track Systems





Hand Operated Curtain Track System

Silent Gliss® 1080

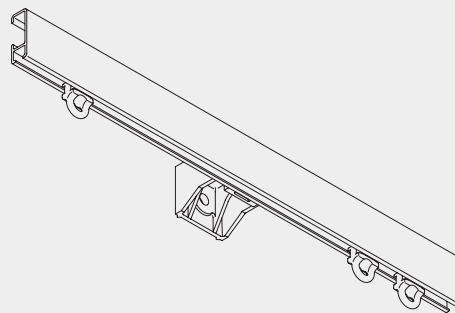

Product Information

- Versatile, sturdy hand-operated curtain track for domestic or contract use
- For medium weight curtains
- Elegant, particularly suited for deep curtain headings
- Standard colours: silver, white, gold, antique bronze, black and cream. Gold and brown brackets are available, otherwise use white
- Standard lengths: 5m (silver and white only), 6m (all colours). Profile connector for longer lengths
- Easy ceiling or wall fixing or can be suspended from hanger rods
- Wide variety of accessories for professional fitters
- Profile also used as picture hanging system and for pelmet/valance rails
- Can be bent



1080

Profile, Bending and Specification Information

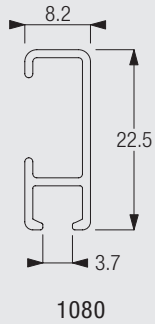

Standard radius 100mm
Arch radius 300mm.

Standard radius is recommended for optimal operation. Minimum possible radius is 60mm.

Specification guide - download from www.silentgliss.co.uk (password protected).

Silent Gliss 1080 curtain track, hand drawn, anodised aluminium complete with gliders 3533 at 16/m, 2 endcover/stops 3667 per length. Face fixed with nylon bracket 3603 each screwed to timber/plugged and screwed to blockwork/concrete at 600mm centres.Lm. Bronze, gold and silver profile anodised aluminium. All other coloured track, powder coated finish.

Fitting Information

Bracket positioning and fixing with universal brackets 3603, 3630, 3655, 3660

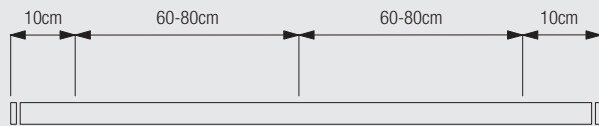

The fixing distances are meant as a guide only: they may vary in practice depending on surface and curtain weight.

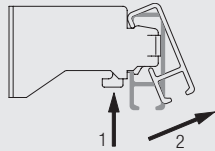
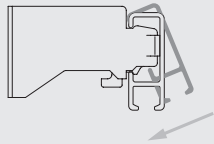

Installation: Roll track onto bracket in direction indicated
Removal: 1. Press to release 2. Rotate forward for removal

1080

Fitting Options

Ceiling fix with bracket 3603

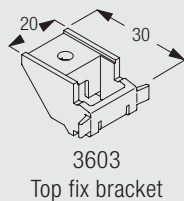
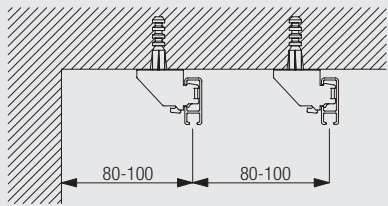

The final distances may be outside of the recommendations above depending on curtain heading, make-up and any obstructions. Batten thickness depends on length of screw.

Ceiling fix with bracket 3603 and bracket arms 3272 - 3274

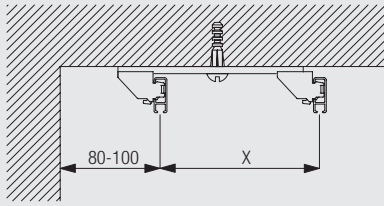

	X (mm)
3272	52
3273	75
3274	105

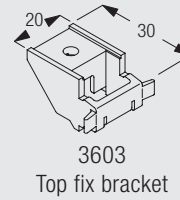
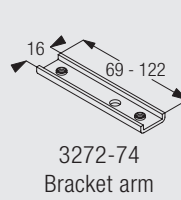

The final distances may be outside of the recommendations above depending on curtain heading, make-up and any obstructions. Batten thickness depends on length of screw.

Suspended fix with bracket 3603 and hanger rod system 3639

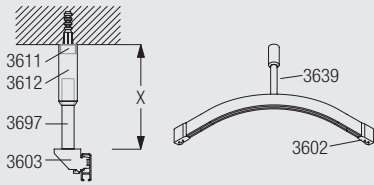

	X (m)
3639	1.25 max

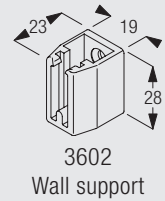
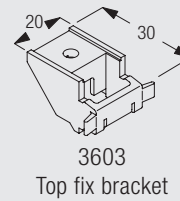
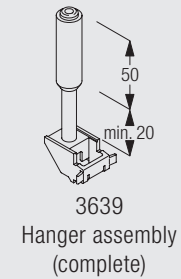

Wall fix with universal brackets 3630/3655/3660

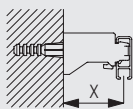

	X (mm)
3630	33
3655	48
3660	63

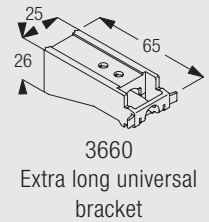
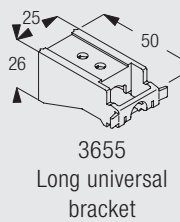
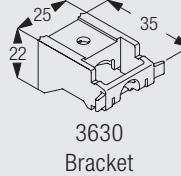

Wall fix with brackets 3134-39 and bracket 3603

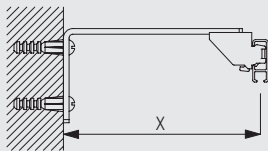

	X (mm)	W (mm)	Y (mm)	Z (mm)
3134	71	-	50	-
3135	91	-	50	50
3136	111	-	50	50
3137	131	-	80	50
3138	161	60	80	60
3139	211	85	80	85

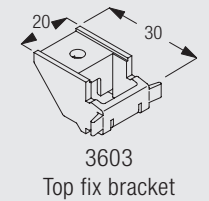
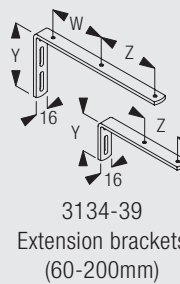

Brackets are threaded for screw 6748 (M4 x 8)

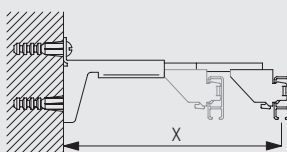

Wall fix with adjustable bracket support 3271 / bracket plates 3272-74 and bracket 3603



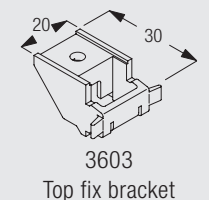
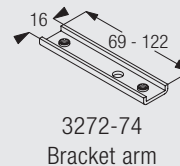
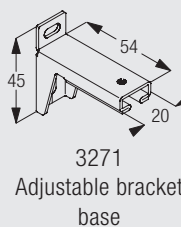





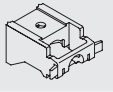









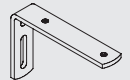
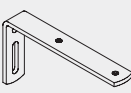
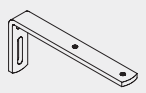
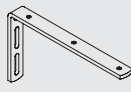
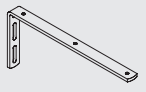

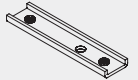
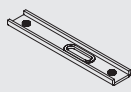
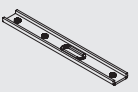
	X (mm)
3275	64-110
3276	104-134
3277	134-164

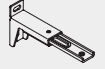
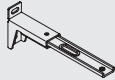





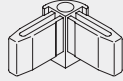

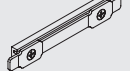
Standard Accessories

			1080	Profile	
3534	Glider 3533 in strip form		3630	Bracket	
3667	Endcover (32mm)				

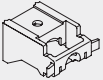
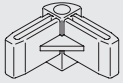
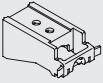
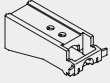



Optional Accessories

0516	Pelmet spacer		3016	Endstop	
3017	Endstop		3070	Twist eye endstop	
3071	Screw twist endstop		3133	Bracket cover (60mm)	
3134	Extension bracket (60mm)		3135	Extension bracket (80mm)	
3136	Extension bracket (100mm)		3137	Extension bracket (120mm)	
3138	Extension bracket (150mm)		3139	Extension bracket (200mm)	
3271	Adjustable bracket base		3272	Adjustable bracket arm (69mm)	
3273	Adjustable bracket arm (92mm)		3274	Adjustable bracket arm (122mm)	
3275	Adjustable extension bracket set (69mm)		3276	Adjustable extension bracket set (92mm)	
3277	Adjustable extension bracket set (122mm)		3533	Glider	
3548	Retrofit glider		3570	Rotating glider	
3602	Wall support		3603	Top fix bracket	
3604	Corner piece		3606	Snap fastener	
3618	Wall support		3620	Connecting bridge	

1080

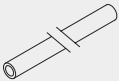
3626	Return fixing bracket		3630	Bracket	
3638	Re-inforced corner piece for pelmets		3655	Long universal bracket	
3660	Extra long universal bracket		6748	Cheese head machine screw (M4)	
10430	Draw rod with hook, 50cm		10431	Draw rod with hook, 75cm	
10432	Draw rod with hook, 100cm		10433	Draw rod with hook, 125cm	
10434	Draw rod with hook, 150cm		3133L	Extended bracket cover for 3137/8/9	

Sets

3639	Hanger rod assembly		3697	Rod	1	
			3611	Stud	1	
			3612	Support with screw	1	
			3699	Track insert	1	



1080

Useful Information and Sewing Accessories

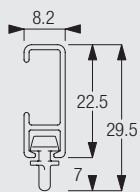
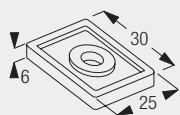

Diagram uses standard 3533/3534 glider and is measured to the inside of the glider eye. For optional gliders substitute dimensions below:
 3570 = 6.0mm
 3548 = 7.5mm

3562	Standard tape		3571	Hook	
3582	Hook		3599	Hook	
6146	Hook				

Useful Measurements

0516 Pelmet spacer



3620 Connecting bridge

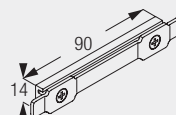

1080



1080



1080



1080

www.silentgliss.co.uk

www.silentglissglobal.com

Silent Gliss Ltd
Pyramid Business Park
Poorhole Lane
Broadstairs
Kent
CT10 2PT
Great Britain

Tel: +44 (0) 1843 863571
Fax: +44 (0) 1843 864503
info@silentgliss.co.uk

Silent Gliss Global Ltd
Pyramid Business Park
Poorhole Lane
Broadstairs
Kent
CT10 2PT
Great Britain

Tel: +44 (0) 1843 874250
Fax: +44 (0) 1843 874457
info@silentglissglobal.com