

Roman Blind Systems





Chain Operated Roman Blind System

Silent Gliss® 2120

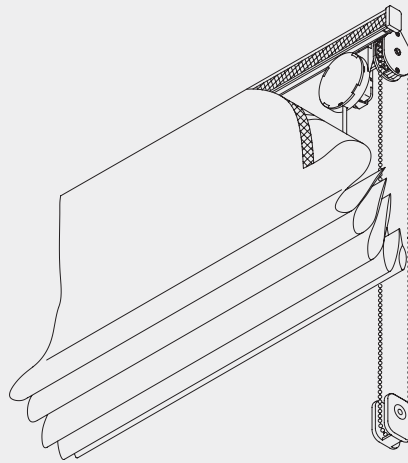

Product Information

- Delivered ready-assembled to exact size for attaching to blind and fitting
- For blinds up to 4m in width and a drop of up to 6m
- The endless bead chain operation makes 2120 ideal for blinds which are large or inaccessible or where trailing cords are not suitable
- Left or right hand pull
- Blinds weighing up to 8kg can be effortlessly operated
- No locking-off required - blind stops without slipping at any required position
- Simple ceiling or wall fixing
- With universal joint 2072A, blinds for bay windows can be achieved in one system
- Single or double bends are possible up to 4m with weight limitations
- Compliant with Child Safety Legislation (EN13120)



2120

Profile, Bending and Specification Information

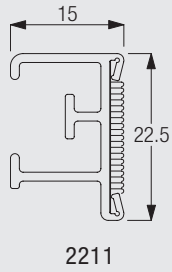

Specification Guide - download from www.silentgliss.co.uk (password required).

Silent Gliss 2120 chain operated headrail system for Roman/Austrian blinds. Ready assembled with Silent Gliss fabric colour / for customer to attach own fabric. Headrail 2211 fixed with standard accessories according to Silent Gliss main catalogue. Bead chain operation, left hand pull/right hand pull via 2049 gear drive. Take-up reel 2081 atcm centres supplied with drawing tape 2163.

System Dimensions



4m



6m



24



8kg

Max 1.25kg per spool

The system dimensions depend on the total fabric weight including the bottom bar, lead weight tapes and cross rods (for hard fold roman blinds).

Fitting and Sewing Information

WARNING



2120

Young children can be strangled by loops in pullcords, chains, tapes and inner cords that operate the product. To avoid strangulation and entanglement, keep cords out of the reach of young children. Cords may become wrapped around a child's neck. Move beds, cots and furniture away from window covering cords. Do not tie cords together. Make sure cords do not twist to create a loop.

Bracket positioning and fixing

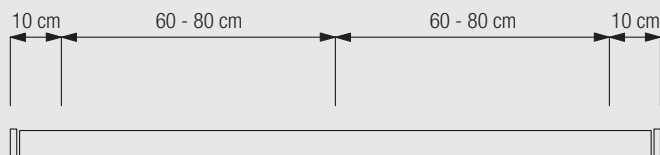

The effective measurements are determined by the actual height, width, structure and make-up style of the curtain.



Applicable with brackets 3603/3630/3655/3660

Installation: Roll track onto bracket in direction indicated.
Removal: 1. Press to release 2. Rotate forward for removal.

Fixing of cords / tapes

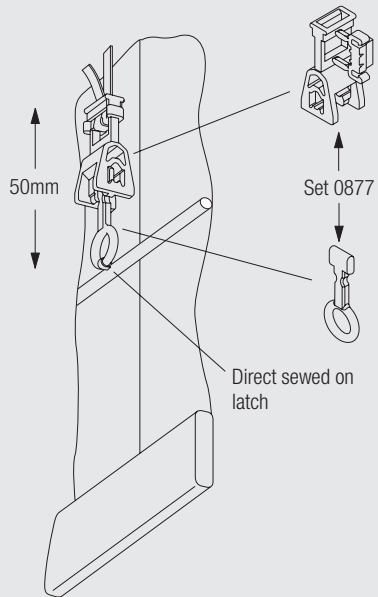

Using Breakaway Bottom Bar Set 0877

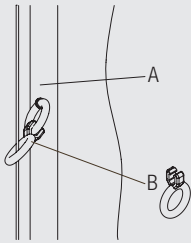

Soft fold:

A: Breakaway Ring Tape Set 0879
 B: Set includes Child Safety Eyelet

Note: The Breakaway Ring Set is available without tape (part number 0878).

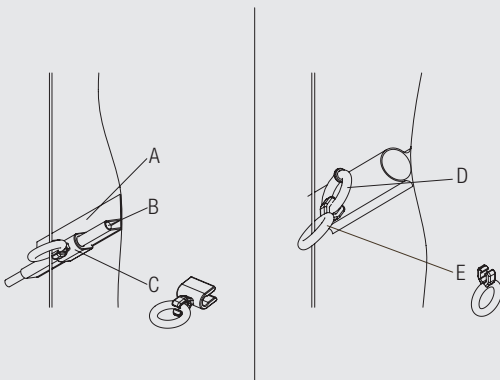

Hard fold:

A: Tape 2136
 B: Steel rod 2135
 C: Child Safety Eyelet (hard fold) 3069

D+E: Breakaway Ring Set 0878



2120

Fitting Options

Ceiling fix with bracket 3603

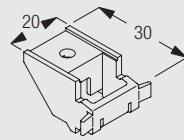
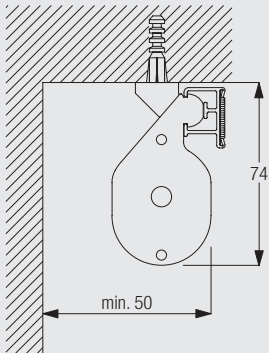

3603
Top fix bracket

Wall fix with brackets 3630, 3655 and 3660

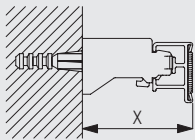

	x
3630	43mm
3655	58mm
3660	73mm

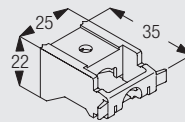

3630
Bracket

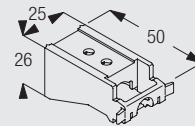

3655
Long universal
bracket

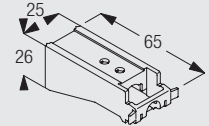

3660
Extra long universal
bracket

Wall fix with brackets 3134-39 and bracket 3603

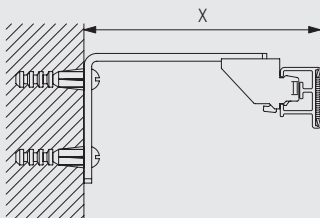

	x (mm)	w (mm)	y (mm)	z (mm)
3134	71mm	-	50	-
3135	91mm	-	50	50
3136	111mm	-	50	50
3137	131mm	-	80	50
3138	161mm	60	80	60
3139	211mm	85	80	85

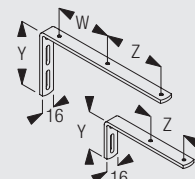

3134-39
Extension brackets
(60-200mm)

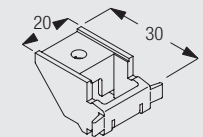

3603
Top fix bracket

Brackets feature thread for screw 6748 for fixing the bracket 3603

Wall fix with adjustable brackets 3275-77

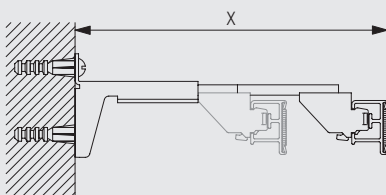

	X (mm)
3275	73-119
3276	90-143
3277	143-173

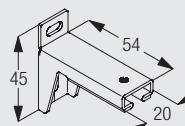

3271
Adjustable bracket
base

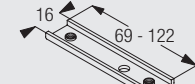



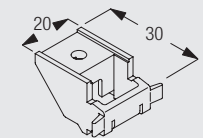







3272-74
Bracket arm

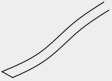

3603
Top fix bracket



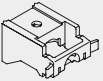







Brackets feature thread for screw 6748 for fixing the bracket 3603.
Brackets 3275-77 are a combination of 3271 and 3272-74.

Standard Accessories

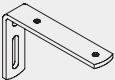
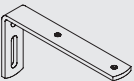
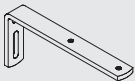
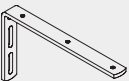
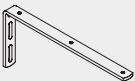
2049	Gear drive		2059	Safety clip	
2081	Take-up reel		2111	Hexagonal bar	
2163	Flat drawing tape		2179	Endcover (24.8mm)	
2211	Velcro profile		2865	Bead chain connector	
3630	Bracket		4845	Metal bead chain	
10400	Safety Cord Retainer				

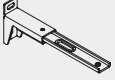
For general fabric make-up and components see system 2100

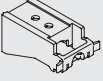
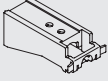
Optional Accessories

2006	Weight bar		2048	Plastic bead chain	
2579	Auxiliary brake		3133	Bracket cover (60mm)	
3134	Extension bracket (60mm)		3135	Extension bracket (80mm)	
3136	Extension bracket (100mm)		3137	Extension bracket (120mm)	
3138	Extension bracket (150mm)		3139	Extension bracket (200mm)	
3275	Adjustable extension bracket set (69mm)		3276	Adjustable extension bracket set (92mm)	
3277	Adjustable extension bracket set (122mm)		3603	Top fix bracket	
3655	Long universal bracket		3660	Extra long universal bracket	
6748	Cheese head machine screw (M4)		3133L	Extended bracket cover for 3137/8/9	



2120

Sewing Accessories

0877 Breakaway bottom bar set



0878 Breakaway ring set (soft fold)



0879 Breakaway ring tape (soft fold)



2135 Steel rod



2136 Rod Tape



3069 Breakaway rod cover (hard fold)



2120



2120



2120



2120

www.silentgliss.co.uk

www.silentglissglobal.com

Silent Gliss Ltd
Pyramid Business Park
Poorhole Lane
Broadstairs
Kent
CT10 2PT
Great Britain

Tel: +44 (0) 1843 863571
Fax: +44 (0) 1843 864503
info@silentgliss.co.uk

Silent Gliss Global Ltd
Pyramid Business Park
Poorhole Lane
Broadstairs
Kent
CT10 2PT
Great Britain

Tel: +44 (0) 1843 874250
Fax: +44 (0) 1843 874457
info@silentglissglobal.com