

Hand Operated Curtain Track Systems





Hand Operated Curtain Track System

Silent Gliss® 1280

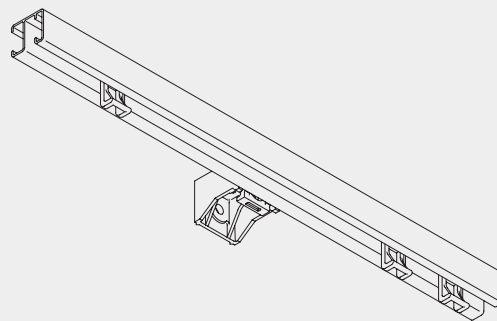

Product Information

- Versatile hand operated curtain track system for contract and domestic applications
- For medium to heavy weight curtains
- Patented roller gliders glide on rim of front channel with very little friction for smooth and easy operation
- Standard profile colour: white
- Easy wall or ceiling fixing
- Available in 4m, 5m and 6m lengths
- Can be bent



1280

Profile, Bending and Specification Information

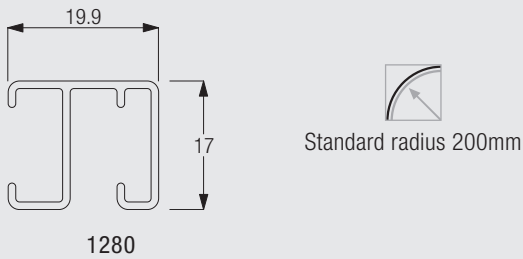

The standard radius is recommended for optimal operation. The minimum possible radius is 150mm.

Specification Guide- download from www.silentgliss.co.uk (password required).

Silent Gliss 1280 hand drawn curtain track in white powder-coated aluminium. Use roller gliders 3922 at 10/m, fix to wall with brackets 3630/3660, ceiling with brackets 3603 every 300mm. Fit endcovers 3985.

Fitting Information

Bracket positioning and fixing with universal brackets 3603, 3630, 3655, 3660



The fixing distances are meant as a guide only: they may vary in practice depending on the surface and curtain weight.

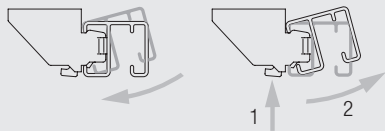

Installation: Roll track onto bracket in direction indicated
Removal: 1. Press to release 2. Rotate forward for removal



Quick-clip glider 3933

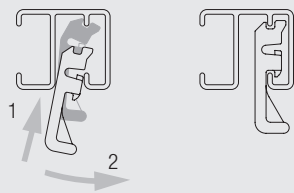

System 1280 is supplied with 3922 roller glider as standard, quick-clip glider 3933 is available as an optional accessory.

Fitting Options

Ceiling fix with bracket 3603

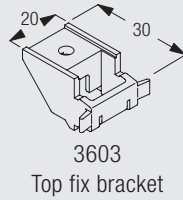
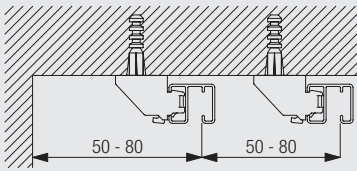

The final distances may be outside of the recommendations above depending on curtain heading, make-up and any obstructions.

Wall fix with universal brackets 3630/3655/3660

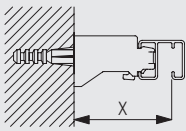

	X (mm)
3630	42
3655	57
3660	72

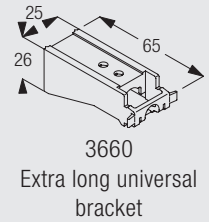
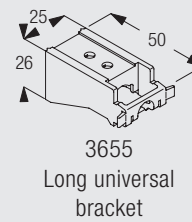
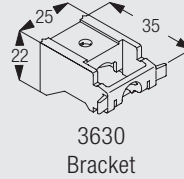

Wall fix with brackets 3134-39 and bracket 3603

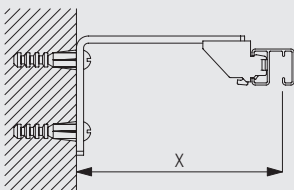

	X (mm)	W (mm)	Y (mm)	Z (mm)
3134	84	-	50	-
3135	104	-	50	50
3136	124	-	50	50
3137	144	-	80	50
3138	174	60	80	60
3139	224	85	80	85

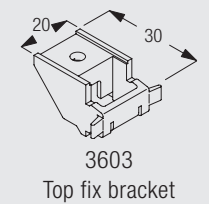
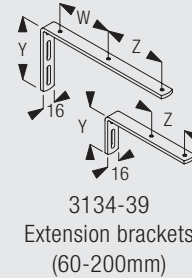

Brackets are threaded for screw 6748 (M4 x 8).

Wall fix with extension brackets 3275-77

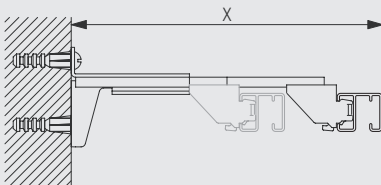

	X (mm)
3275	81-110
3276	104-134
3277	134-164

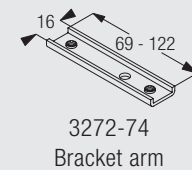
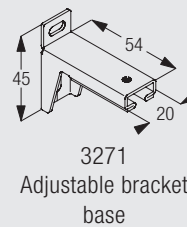

Standard Accessories

3630 Bracket

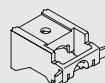

1280 Profile



3922 Roller 3911 in strip form



3985 Endcover 

Optional Accessories

3133 Bracket cover (60mm) 

3135 Extension bracket (80mm) 

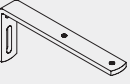
3137 Extension bracket (120mm) 

3139 Extension bracket (200mm) 

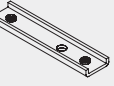
3272 Adjustable bracket arm (69mm) 

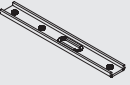
3274 Adjustable bracket arm (122mm) 

3276 Adjustable extension bracket set (92mm) 

3603 Top fix bracket 

3660 Extra long universal bracket 

3933 Glider 3933 in strip form 

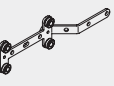
3975 Overlap arm for pulling by hand 

10430 Draw rod with hook, 50cm 

10432 Draw rod with hook, 100cm 

10434 Draw rod with hook, 150cm 

3935A Overlap arm straight with S-hook 3949 

3134 Extension bracket (60mm) 

3136 Extension bracket (100mm) 

3138 Extension bracket (150mm) 

3271 Adjustable bracket base 

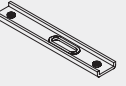
3273 Adjustable bracket arm (92mm) 

3275 Adjustable extension bracket set (69mm) 

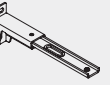
3277 Adjustable extension bracket set (122mm) 

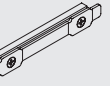
3620 Connecting bridge 

3932 Spring stop 

3942 Endstop 

6748 Cheese head machine screw (M4) 

10431 Draw rod with hook, 75cm 

10433 Draw rod with hook, 125cm 

3133L Extended bracket cover for 3137/8/9 

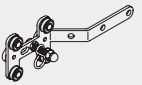
3936A Overlap arm with s-hook 3949 

1280

Useful Information and Sewing Accessories

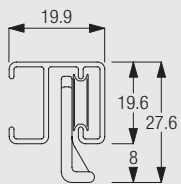
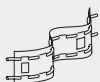

Diagram uses standard 3922 glider and is measured to the inside of the glider eye. For optional gliders substitute dimensions below:

3945/3946 = 8mm

3933 = 8mm

3562 Standard tape



3582 Hook



3599 Hook



Useful Measurements

3620 Connecting bridge

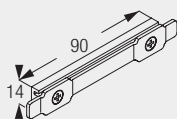

1280

www.silentgliss.co.uk

www.silentglissglobal.com

Silent Gliss Ltd
Pyramid Business Park
Poorhole Lane
Broadstairs
Kent
CT10 2PT
Great Britain

Tel: +44 (0) 1843 863571
Fax: +44 (0) 1843 864503
info@silentgliss.co.uk

Silent Gliss Global Ltd
Pyramid Business Park
Poorhole Lane
Broadstairs
Kent
CT10 2PT
Great Britain

Tel: +44 (0) 1843 874250
Fax: +44 (0) 1843 874457
info@silentglissglobal.com